

For reference only. See data sheet for the detailed specifications.

Technical Specification

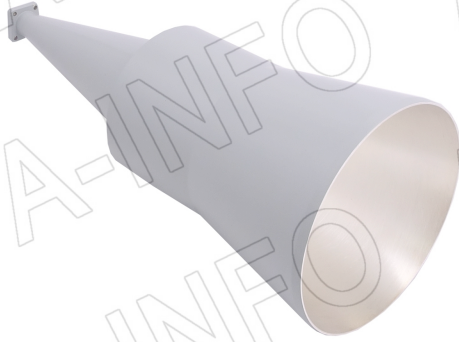

Frequency Range(GHz)	17.5 – 20.5
Circular WG Size	11.94mm / 0.47"
Gain(dBi)	25 Typ.
Polarization	Linear and Circular
3dB Beamwidth(deg)	E Plane: 8 Typ.
	H Plane: 10 Typ.
Cross Pol. Isolation(dB)	40 Typ.
VSWR	1.20:1 Max.
Output	UG-595/U-M
Material	Al
Finish	Sliver Plated, Gray Paint
Size(mm)	121.9 x 121.9 x 294.84
Net Weight(Kg)	0.63 Around

Outline Drawing (Size: mm)

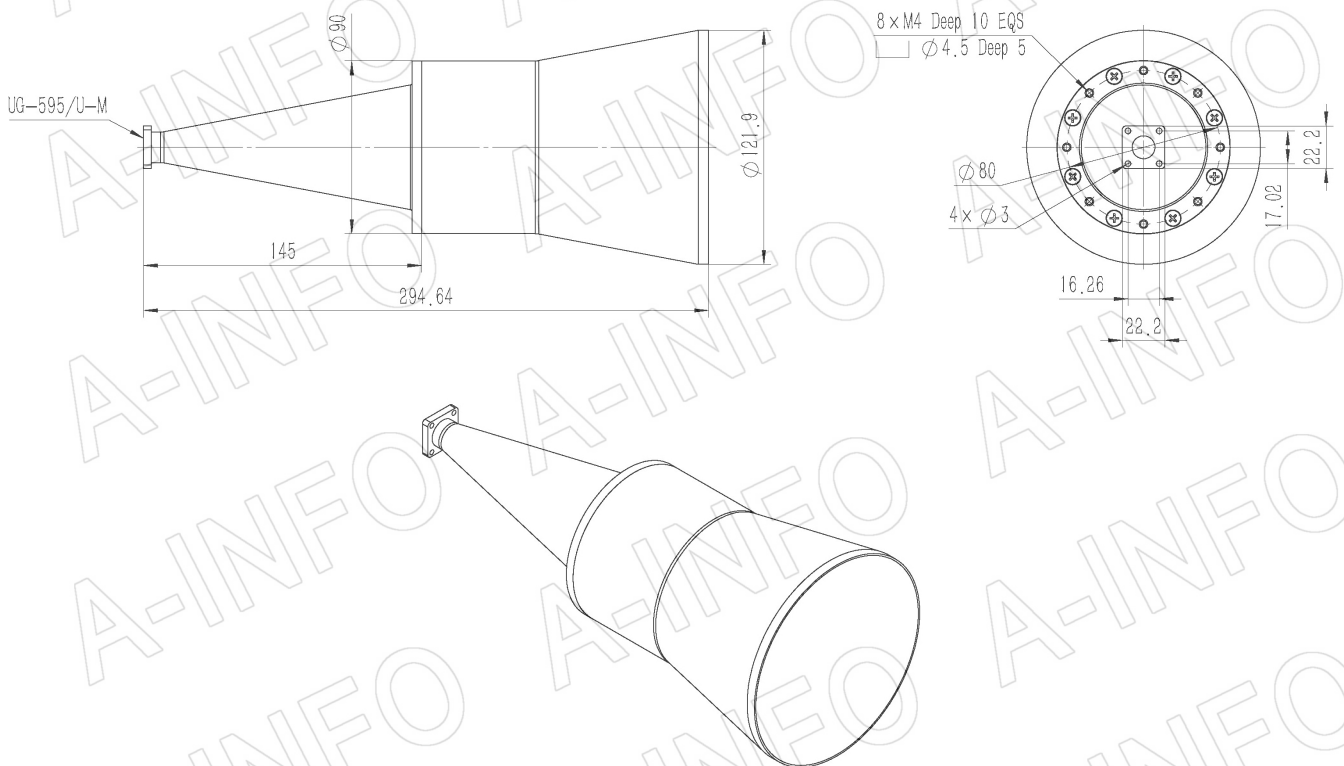

Flange Drawing (Size: mm)

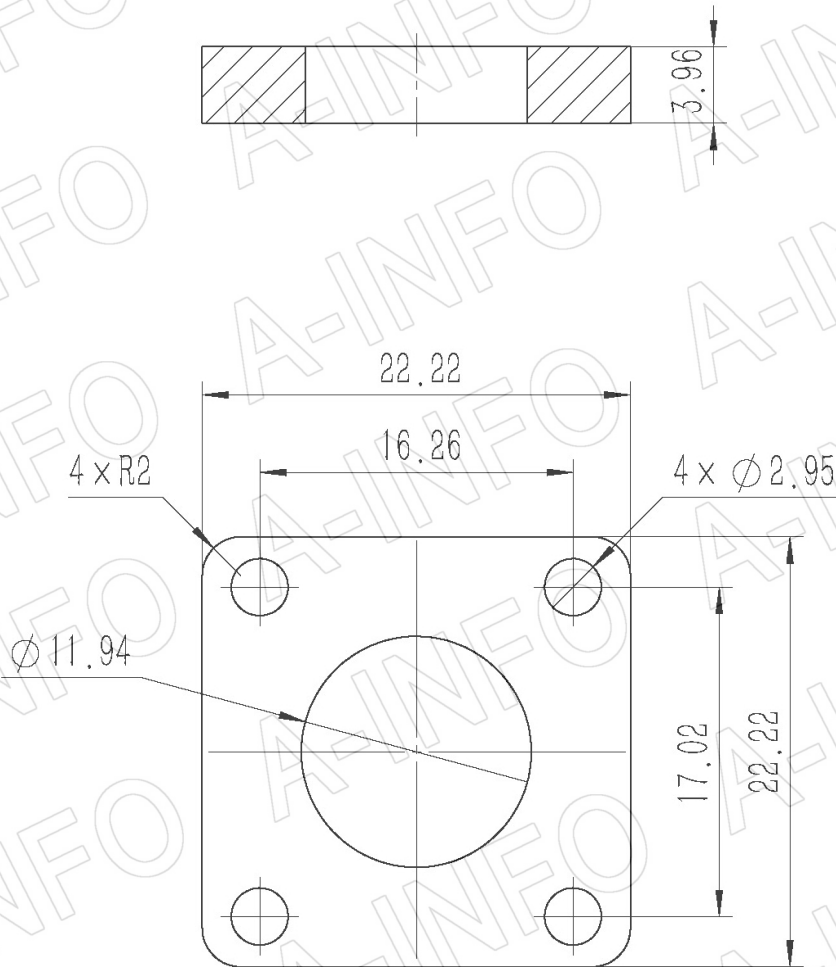

UG-595/U-M

Test Results (Including circular to rectangular transition)

1. Gain & Antenna Factor

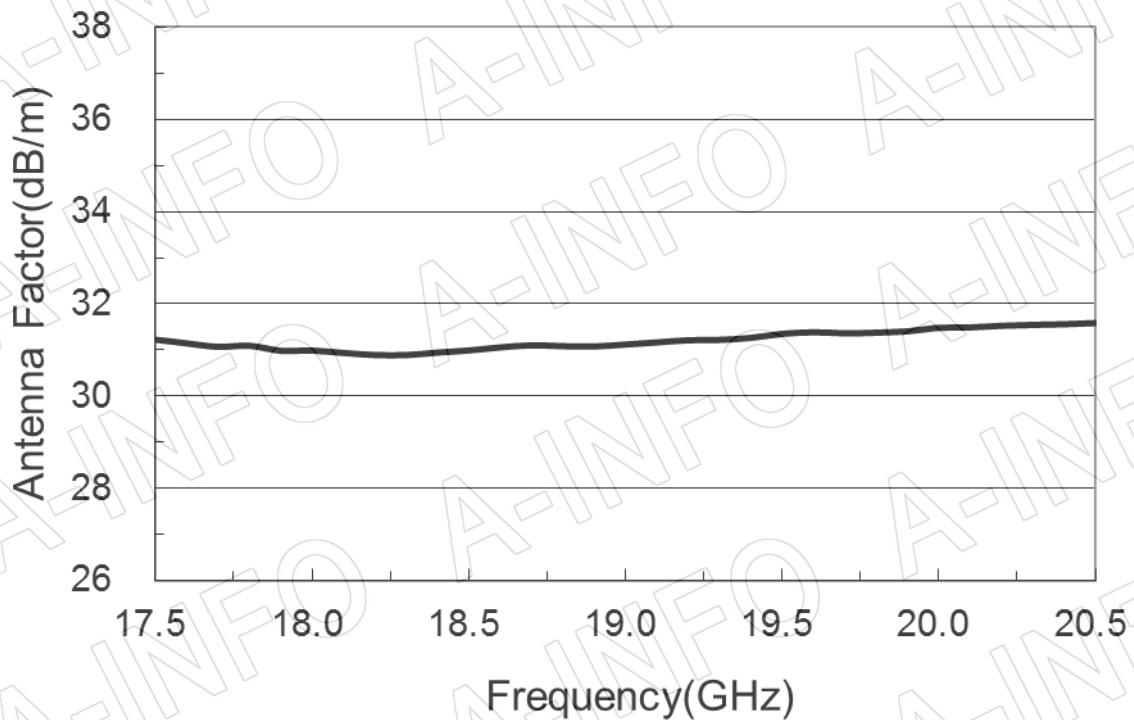
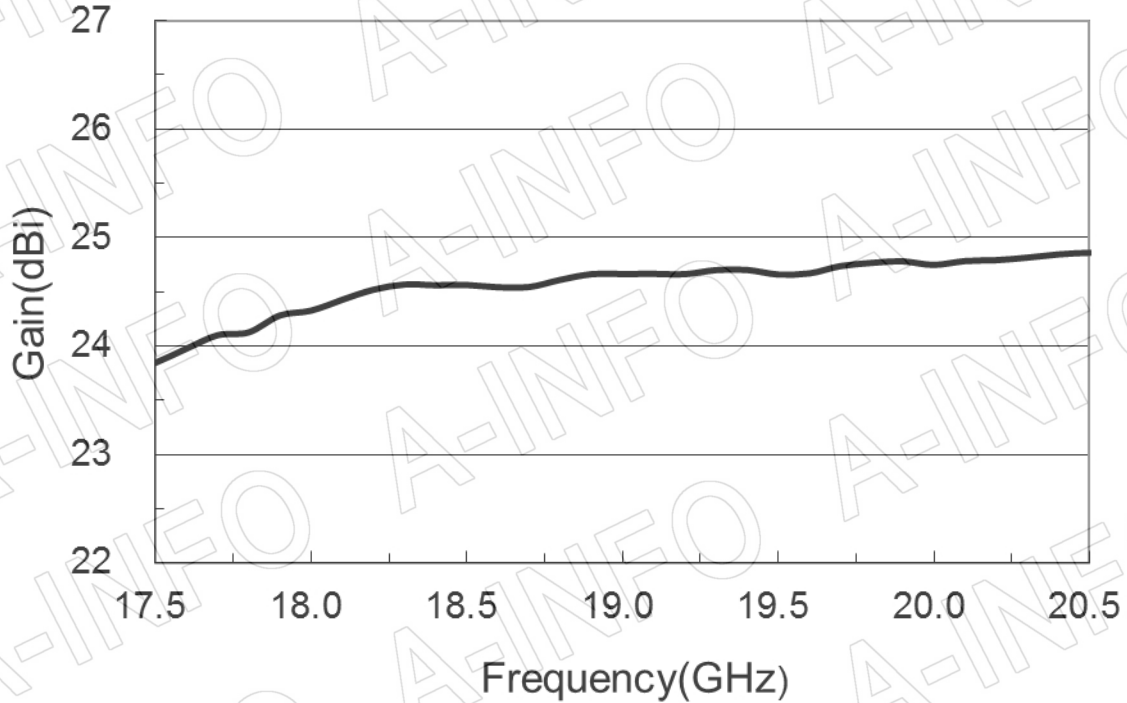

2. Cross Polarization Isolation

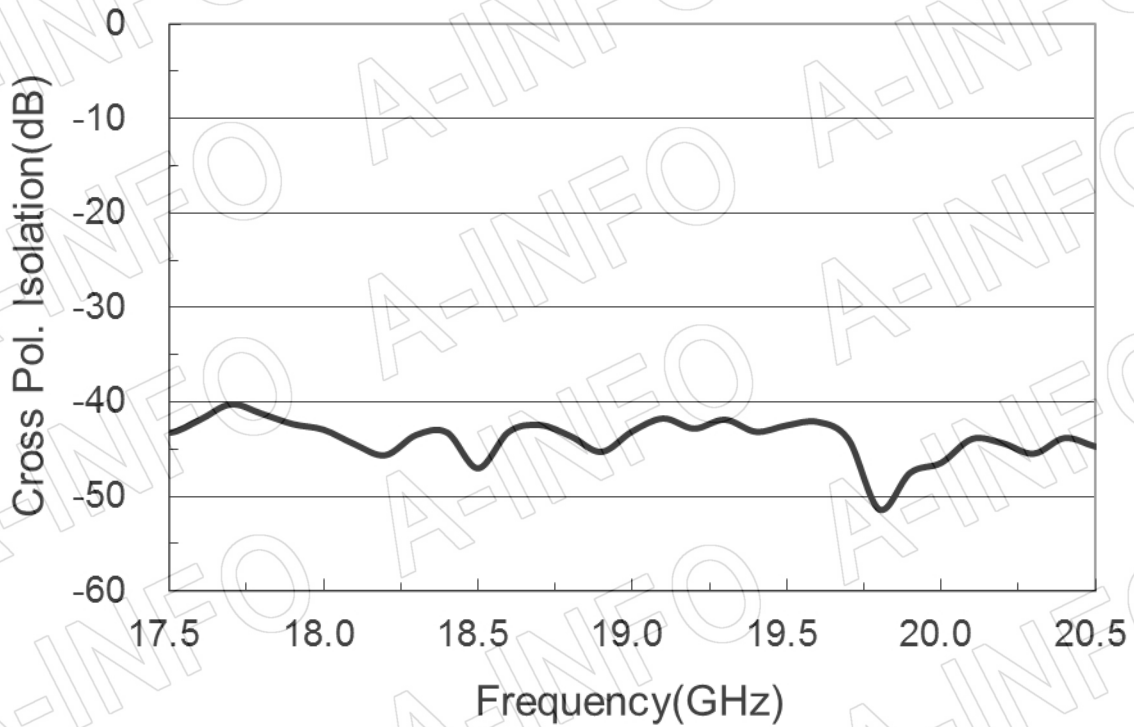

3. VSWR

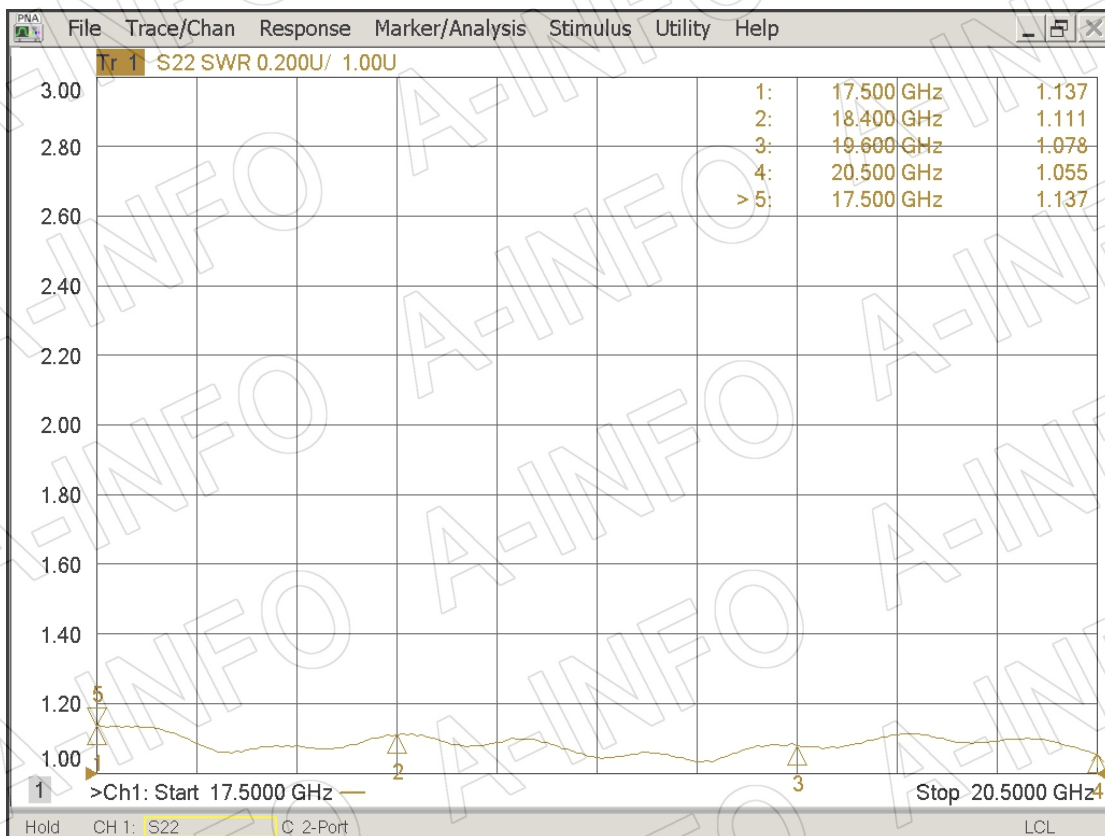

4. Pattern

